

PHE13005

Silicon diffused power transistor

Rev. 03 — 20 November 2009

Product data sheet

1. Product profile

1.1 General description

High voltage, high speed NPN planar-passivated power switching transistor in a SOT78 plastic package intended for use in high frequency electronic lighting ballast applications

1.2 Features and benefits

- Fast switching
- High voltage capability of 700 V
- Low thermal resistance

1.3 Applications

- Electronic lighting ballasts

1.4 Quick reference data

Table 1. Quick reference

Symbol	Parameter	Conditions	Min	Typ	Max	Unit
I_C	collector current	DC; see Figure 3, 1 and 2	-	-	4	A
P_{tot}	total power dissipation	$T_{mb} \leq 25\text{ °C}$; see Figure 4	-	-	75	W
V_{CESM}	collector-emitter peak voltage	$V_{BE} = 0\text{ V}$	-	-	700	V
Static characteristics						
h_{FE}	DC current gain	$I_C = 1\text{ A}$; $V_{CE} = 5\text{ V}$; $T_{mb} = 25\text{ °C}$; see Figure 11	12	20	40	
		$I_C = 2\text{ A}$; $V_{CE} = 5\text{ V}$; $T_{mb} = 25\text{ °C}$; see Figure 11	10	17	28	

2. Ordering information

Table 2. Ordering information

Type number	Package		Version
	Name	Description	
PHE13005	TO-220AB	plastic single-ended package; heatsink mounted; 1 mounting hole; 3-lead TO-220AB	SOT78

3. Limiting values

Table 3. Limiting values

In accordance with the Absolute Maximum Rating System (IEC 60134).

Symbol	Parameter	Conditions	Min	Max	Unit
V_{CESM}	collector-emitter peak voltage	$V_{BE} = 0\text{ V}$	-	700	V
V_{CBO}	collector-base voltage	$I_E = 0\text{ A}$	-	700	V
V_{CEO}	collector-emitter voltage	$I_B = 0\text{ A}$	-	400	V
I_C	collector current	DC; see Figure 3, 1 and 2	-	4	A
I_{CM}	peak collector current		-	8	A
I_B	base current		-	2	A
I_{BM}	peak base current		-	4	A
P_{tot}	total power dissipation	$T_{mb} \leq 25\text{ °C}$; see Figure 4	-	75	W
T_{stg}	storage temperature		-65	150	°C
T_j	junction temperature		-	150	°C

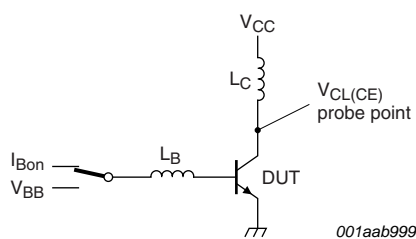

$$V_{CL(CE)} \leq 1000\text{ V}; V_{CC} = 150\text{ V}; V_{BB} = -5\text{ V};$$

$$L_B = 1\text{ }\mu\text{H}; L_C = 200\text{ }\mu\text{H}$$

Fig 1. Test circuit for reverse bias safe operating area

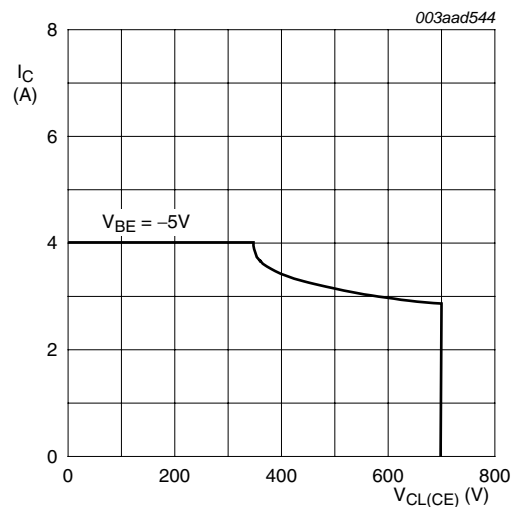

$$T_j \leq T_{j(max)}\text{ °C}$$

Fig 2. Reverse bias safe operating area

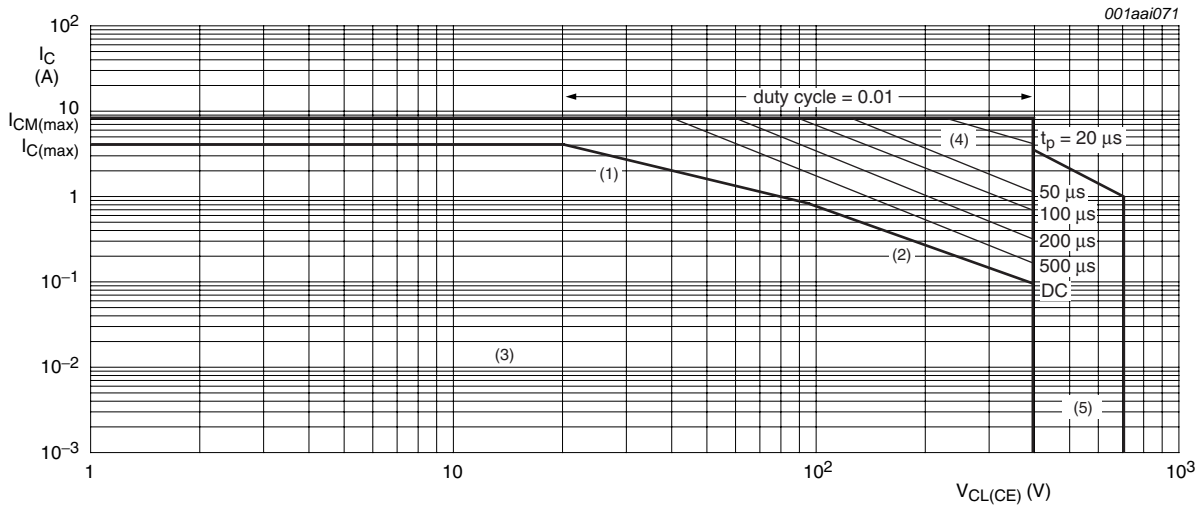

$T_h \leq 25^\circ\text{C}$ Mounted with heatsink compound and $(30 \pm 5)\text{N}$ force on the centre of the envelope

- (1) P_{tot} maximum and P_{tot} peak maximum lines
- (2) Second breakdown limits
- (3) Region of permissible DC operation
- (4) Extension of operating region for repetitive pulse operation
- (5) Extension of operating region during turn-on in single transistor converters provided that $R_{BE} \leq 100 \Omega$ and $t_p \leq 0.6 \mu\text{s}$

Fig 3. Forward bias safe operating area

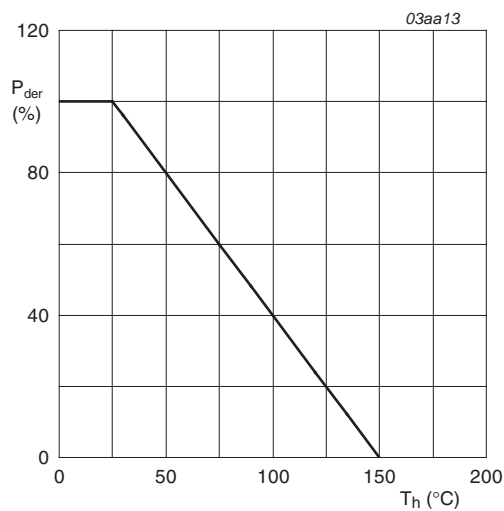

$$P_{der} = \frac{P_{tot}}{P_{tot(25^\circ\text{C})}} \times 100\%$$

Fig 4. Normalized total power dissipation as a function of heatsink temperature

4. Thermal characteristics

Table 4. Thermal characteristics

Symbol	Parameter	Conditions	Min	Typ	Max	Unit
$R_{th(j-mb)}$	thermal resistance from junction to mounting base	see Figure 5	-	-	1.67	K/W
$R_{th(j-a)}$	thermal resistance from junction to ambient		-	60	-	K/W

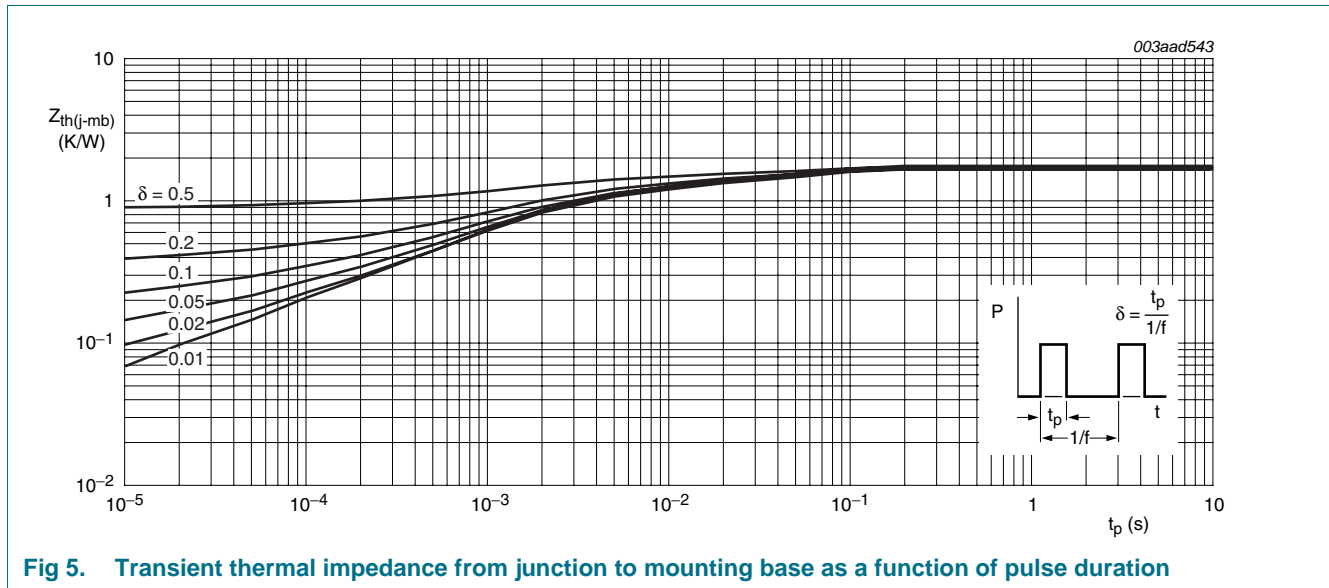

Fig 5. Transient thermal impedance from junction to mounting base as a function of pulse duration

5. Characteristics

Table 5. Characteristics

Symbol	Parameter	Conditions	Min	Typ	Max	Unit
Static characteristics						
I _{CES}	collector-emitter cut-off current	V _{BE} = -1.5 V; V _{CE} = 700 V; T _j = 25 °C	-	-	1	mA
		V _{BE} = -1.5 V; V _{CE} = 700 V; T _j = 100 °C	-	-	5	mA
I _{CBO}	collector-base cut-off current	V _{CB} = 700 V; I _E = 0 A; T _{mb} = 25 °C	-	-	1	mA
I _{CEO}	collector-emitter cut-off current	V _{CE} = 400 V; I _B = 0 A; T _{mb} = 25 °C	-	-	0.1	mA
I _{EBO}	emitter-base cut-off current	V _{EB} = 9 V; I _C = 0 A; T _{mb} = 25 °C	-	-	1	mA
V _{CE0sus}	collector-emitter sustaining voltage	I _B = 0 A; I _C = 10 mA; L _C = 25 mH; T _{mb} = 25 °C; see Figure 6 and 7	400	-	-	V
V _{CEsat}	collector-emitter saturation voltage	I _C = 1 A; I _B = 0.2 A; T _{mb} = 25 °C; see Figure 8 and 9	-	0.1	0.5	V
		I _C = 2 A; I _B = 0.5 A; T _{mb} = 25 °C; see Figure 8 and 9	-	0.2	0.6	V
		I _C = 4 A; I _B = 1 A; T _{mb} = 25 °C; see Figure 8 and 9	-	0.3	1	V
V _{BEsat}	base-emitter saturation voltage	I _C = 1 A; I _B = 0.2 A; T _{mb} = 25 °C; see Figure 10	-	0.85	1.2	V
		I _C = 2 A; I _B = 0.5 A; T _{mb} = 25 °C; see Figure 10	-	0.92	1.6	V
h _{FE}	DC current gain	I _C = 1 A; V _{CE} = 5 V; T _{mb} = 25 °C; see Figure 11	12	20	40	
		I _C = 2 A; V _{CE} = 5 V; T _{mb} = 25 °C; see Figure 11	10	17	28	
Dynamic characteristics						
t _s	storage time	I _C = 2 A; I _{Bon} = 0.4 A; I _{Boff} = -0.4 A; R _L = 75 Ω; T _{mb} = 25 °C; resistive load; see Figure 12 and 13	-	2.7	4	μs
		I _C = 2 A; I _{Bon} = 0.4 A; V _{BB} = -5 V; L _B = 1 μH; T _{mb} = 25 °C; inductive load; see Figure 14 and 15	-	1.2	2	μs
		I _C = 2 A; I _{Bon} = 0.4 A; V _{BB} = -5 V; L _B = 1 μH; T _{mb} = 100 °C; inductive load; see Figure 14 and 15	-	1.4	4	μs
t _f	fall time	I _C = 2 A; I _{Bon} = 0.4 A; I _{Boff} = -0.4 A; R _L = 75 Ω; T _{mb} = 25 °C; resistive load; see Figure 12 and 13	-	0.3	0.9	μs
		I _C = 2 A; I _{Bon} = 0.4 A; V _{BB} = -5 V; L _B = 1 μH; T _{mb} = 25 °C; inductive load; see Figure 14 and 15	-	0.1	0.5	μs
		I _C = 2 A; I _{Bon} = 0.4 A; V _{BB} = -5 V; L _B = 1 μH; T _{mb} = 100 °C; inductive load; see Figure 14 and 15	-	0.16	0.9	μs

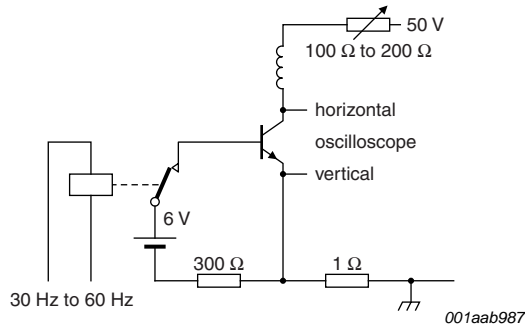

Fig 6. Test circuit for collector-emitter sustaining voltage

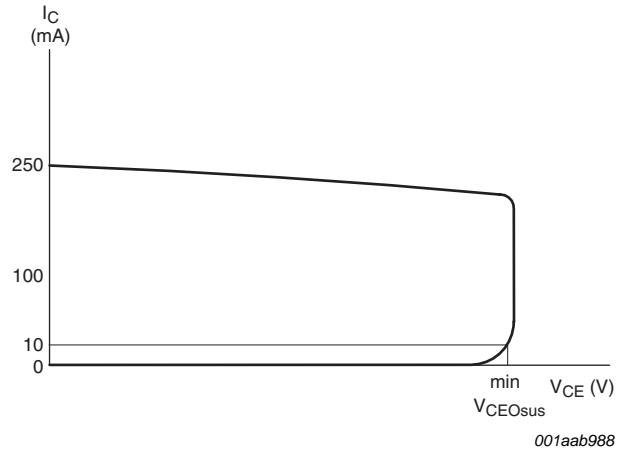

Fig 7. Oscilloscope display for collector-emitter sustaining voltage test waveform

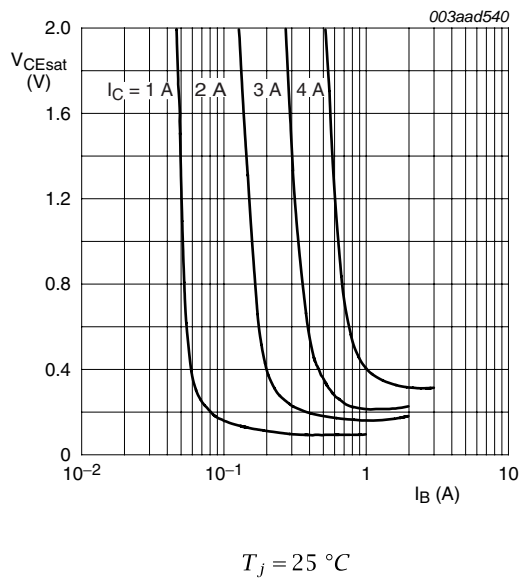

Fig 8. Collector-emitter saturation voltage; typical values

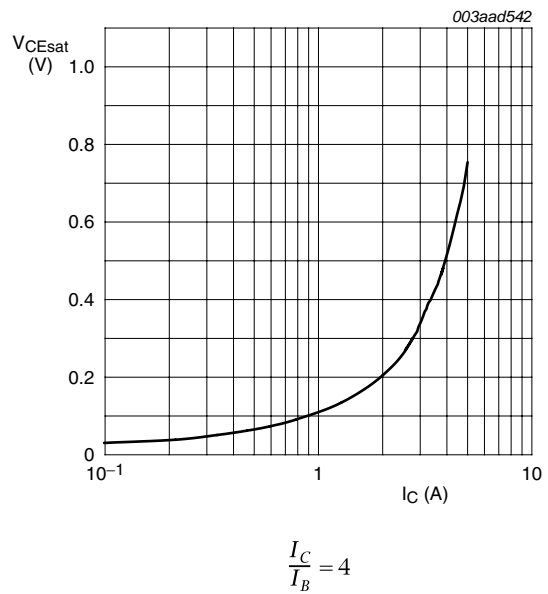
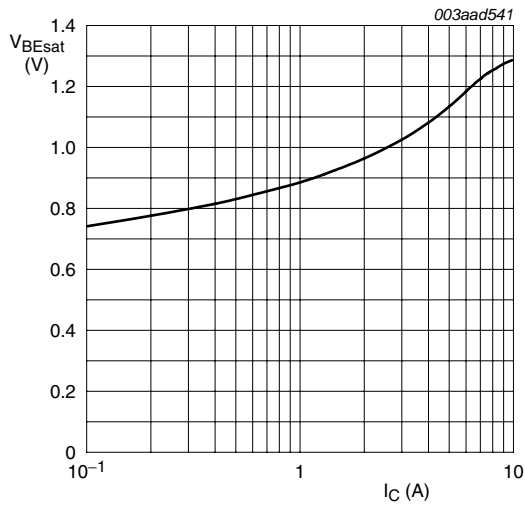
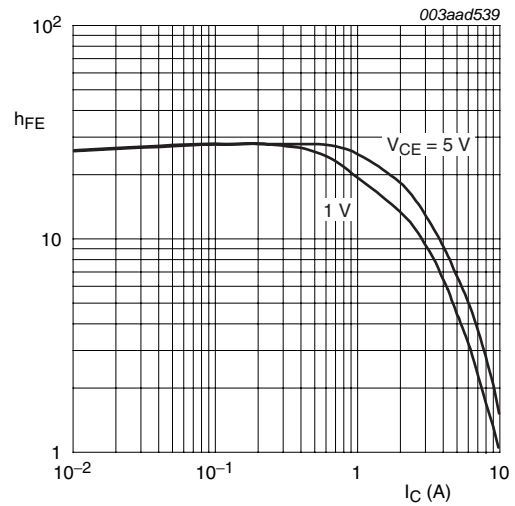

Fig 9. Collector-emitter saturation voltage as a function of collector current; typical values



$$\frac{I_C}{I_B} = 4$$

Fig 10. Base-emitter saturation voltage; typical values



$$T_j = 25 \text{ }^\circ\text{C}$$

Fig 11. DC current gain as a function of collector current; typical values

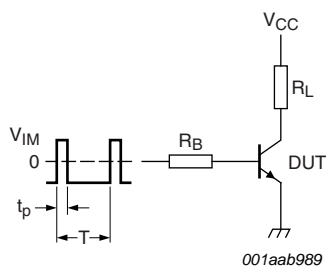

$V_{IM} = -6 \text{ to } +8 \text{ V}$; $V_{CC} = 250 \text{ V}$; $t_p = 20 \text{ } \mu\text{s}$; $\delta = \frac{t_p}{T} = 0.01$
 R_B and R_L calculated from I_{Con} and I_{Bon} requirements.

Fig 12. Test circuit for resistive load switching

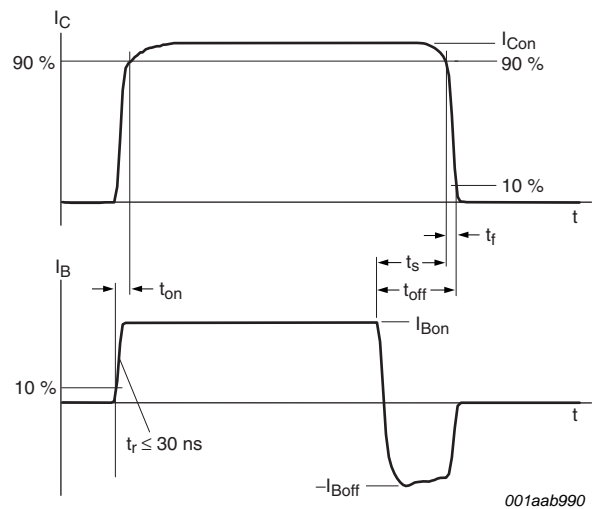
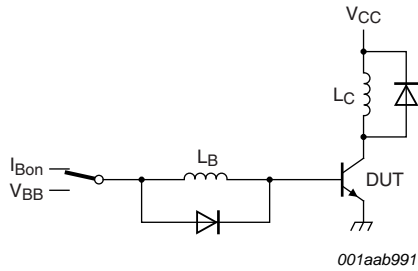

Fig 13. Switching times waveforms for resistive load



$V_{CC} = 300\text{ V}; V_{BB} = -5\text{ V}; L_C = 200\ \mu\text{H}; L_B = 1\ \mu\text{H}$

Fig 14. Test circuit for inductive load switching

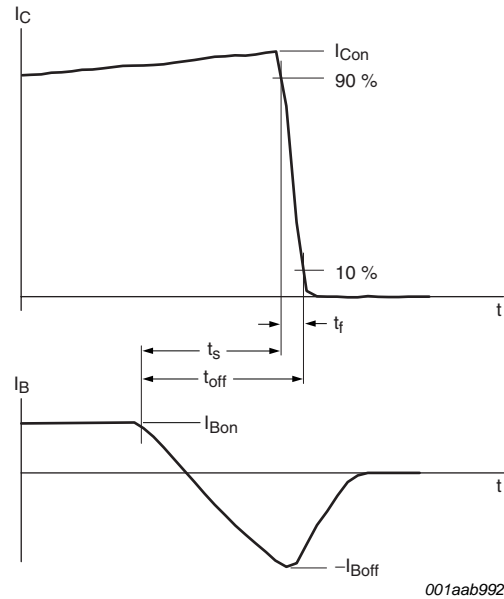

Fig 15. Switching times waveforms for inductive load

6. Package outline

Plastic single-ended package; heatsink mounted; 1 mounting hole; 3-lead TO-220AB

SOT78

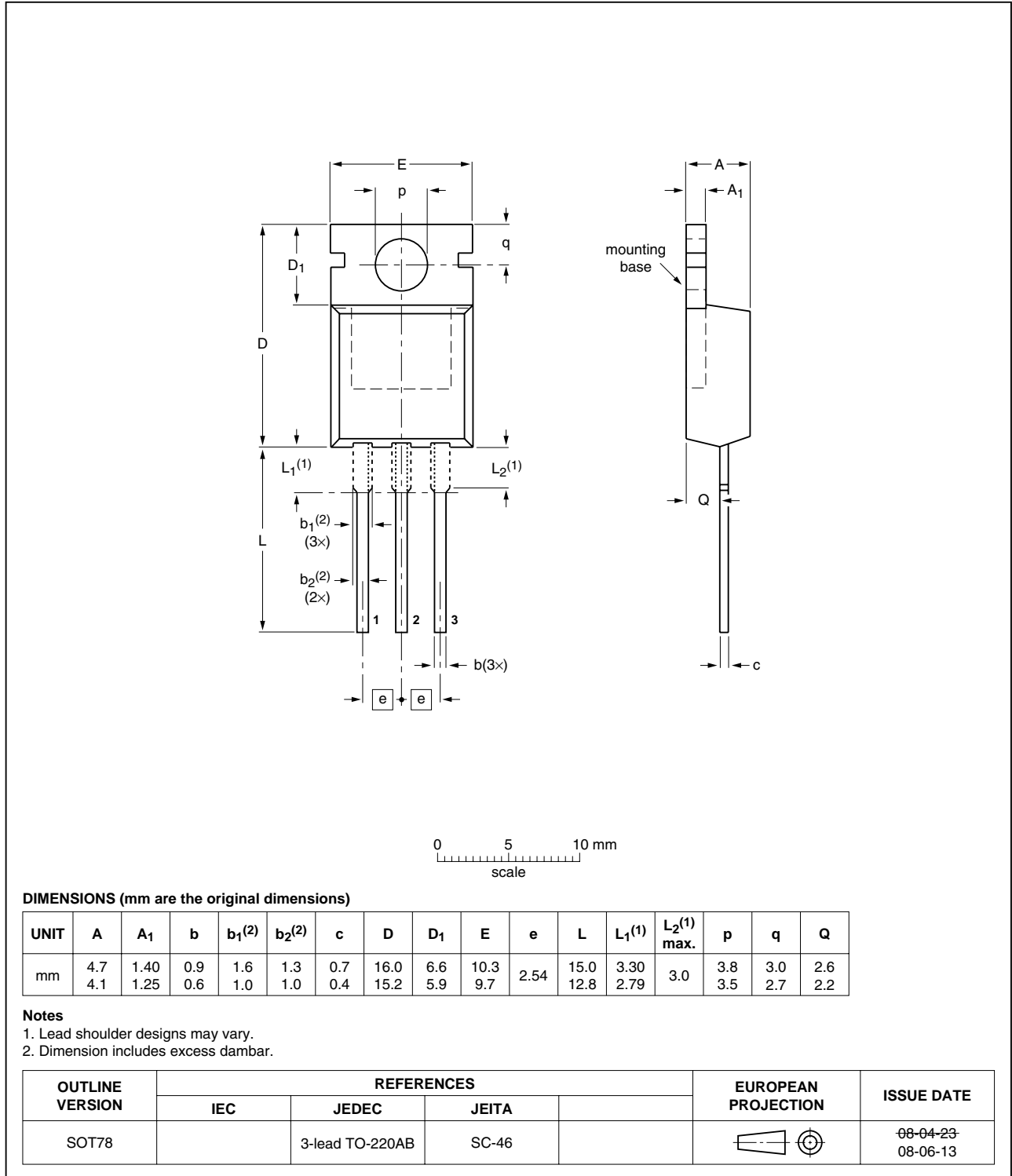

Fig 16. Package outline SOT78 (TO-220AB)

7. Revision history

Table 6. Revision history

Document ID	Release date	Data sheet status	Change notice	Supersedes
PHE13005_3	20091120	Product data sheet	-	PHE13005_2
Modifications:		<ul style="list-style-type: none">• The format of this data sheet has been redesigned to comply with the new identity guidelines of NXP Semiconductors.• Legal texts have been adapted to the new company name where appropriate.		
PHE13005_2	19990201	Product specification	-	PHE13005_1
PHE13005_1	19980801	Preliminary specification	-	-

8. Legal information

8.1 Data sheet status

Document status ^{[1][2]}	Product status ^[3]	Definition
Objective [short] data sheet	Development	This document contains data from the objective specification for product development.
Preliminary [short] data sheet	Qualification	This document contains data from the preliminary specification.
Product [short] data sheet	Production	This document contains the product specification.

[1] Please consult the most recently issued document before initiating or completing a design.

[2] The term 'short data sheet' is explained in section "Definitions".

[3] The product status of device(s) described in this document may have changed since this document was published and may differ in case of multiple devices. The latest product status information is available on the Internet at URL <http://www.nxp.com>.

8.2 Definitions

Draft — The document is a draft version only. The content is still under internal review and subject to formal approval, which may result in modifications or additions. NXP Semiconductors does not give any representations or warranties as to the accuracy or completeness of information included herein and shall have no liability for the consequences of use of such information.

Short data sheet — A short data sheet is an extract from a full data sheet with the same product type number(s) and title. A short data sheet is intended for quick reference only and should not be relied upon to contain detailed and full information. For detailed and full information see the relevant full data sheet, which is available on request via the local NXP Semiconductors sales office. In case of any inconsistency or conflict with the short data sheet, the full data sheet shall prevail.

8.3 Disclaimers

General — Information in this document is believed to be accurate and reliable. However, NXP Semiconductors does not give any representations or warranties, expressed or implied, as to the accuracy or completeness of such information and shall have no liability for the consequences of use of such information.

Right to make changes — NXP Semiconductors reserves the right to make changes to information published in this document, including without limitation specifications and product descriptions, at any time and without notice. This document supersedes and replaces all information supplied prior to the publication hereof.

Suitability for use — NXP Semiconductors products are not designed, authorized or warranted to be suitable for use in medical, military, aircraft, space or life support equipment, nor in applications where failure or malfunction of an NXP Semiconductors product can reasonably be expected to result in personal injury, death or severe property or environmental damage. NXP Semiconductors accepts no liability for inclusion and/or use of NXP Semiconductors products in such equipment or applications and therefore such inclusion and/or use is at the customer's own risk.

Applications — Applications that are described herein for any of these products are for illustrative purposes only. NXP Semiconductors makes no representation or warranty that such applications will be suitable for the specified use without further testing or modification.

Quick reference data — The Quick reference data is an extract of the product data given in the Limiting values and Characteristics sections of this document, and as such is not complete, exhaustive or legally binding.

Limiting values — Stress above one or more limiting values (as defined in the Absolute Maximum Ratings System of IEC 60134) may cause permanent damage to the device. Limiting values are stress ratings only and operation of the device at these or any other conditions above those given in the Characteristics sections of this document is not implied. Exposure to limiting values for extended periods may affect device reliability.

Terms and conditions of sale — NXP Semiconductors products are sold subject to the general terms and conditions of commercial sale, as published at <http://www.nxp.com/profile/terms>, including those pertaining to warranty, intellectual property rights infringement and limitation of liability, unless explicitly otherwise agreed to in writing by NXP Semiconductors. In case of any inconsistency or conflict between information in this document and such terms and conditions, the latter will prevail.

No offer to sell or license — Nothing in this document may be interpreted or construed as an offer to sell products that is open for acceptance or the grant, conveyance or implication of any license under any copyrights, patents or other industrial or intellectual property rights.

Export control — This document as well as the item(s) described herein may be subject to export control regulations. Export might require a prior authorization from national authorities.

8.4 Trademarks

Notice: All referenced brands, product names, service names and trademarks are the property of their respective owners.

9. Contact information

For more information, please visit: <http://www.nxp.com>

For sales office addresses, please send an email to: salesaddresses@nxp.com

10. Contents

- 1 Product profile1**
- 1.1 General description1
- 1.2 Features and benefits1
- 1.3 Applications1
- 1.4 Quick reference data1
- 2 Ordering information2**
- 3 Limiting values2**
- 4 Thermal characteristics4**
- 5 Characteristics5**
- 6 Package outline9**
- 7 Revision history10**
- 8 Legal information11**
- 8.1 Data sheet status11
- 8.2 Definitions11
- 8.3 Disclaimers11
- 8.4 Trademarks11
- 9 Contact information11**

Please be aware that important notices concerning this document and the product(s) described herein, have been included in section 'Legal information'.



© NXP B.V. 2009.

All rights reserved.

For more information, please visit: <http://www.nxp.com>

For sales office addresses, please send an email to: salesaddresses@nxp.com

Date of release: 20 November 2009

Document identifier: PHE13005_3